

A

B

C

D

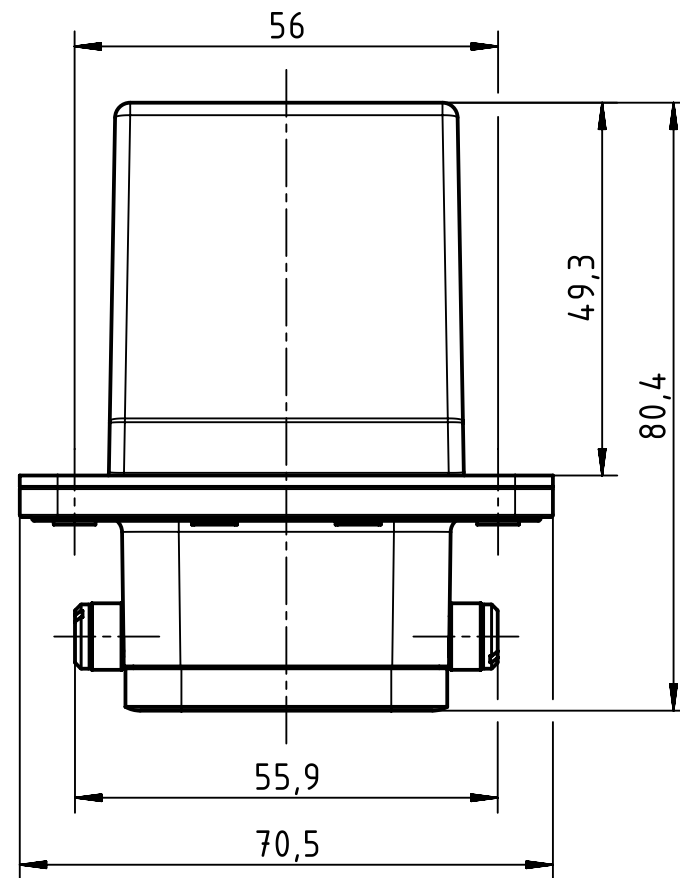
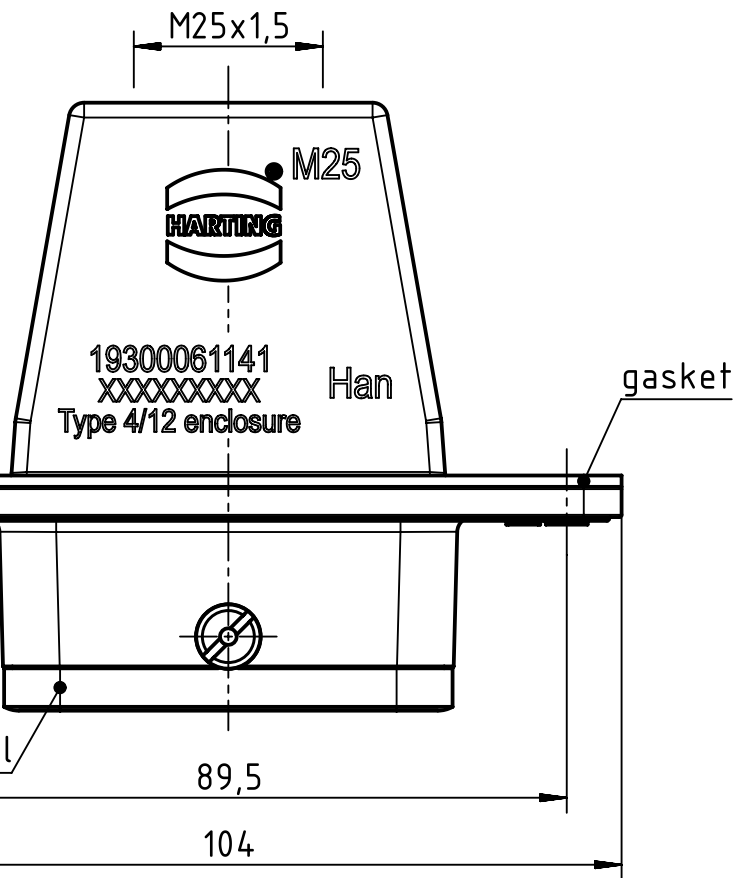

panel cut out (1:3)

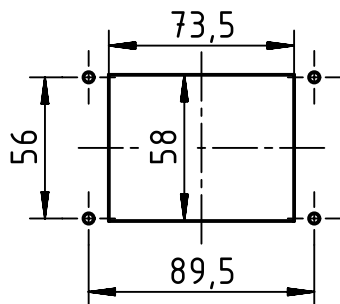

	All rights reserved Department EL PD	All Dimensions in mm Original Size DIN A4		Scale 1:1	Free size tol.	Ref. Sub.
		Created by LONGL	Inspected by HEW	Standardisation RUETERA	Date 2018-05-25	State Final Release
HARTING (Zhuhai) Manufacturing Co., Ltd. 519085 Zhuhai, China		Title Han 6B HTE M25 PFT CL			Doc-Key / ECM-Nr. 100733551/UGD/001/B 500000135509	
		Type TB	Number 19 30 006 1141		Rev. B	Page 1/1